

Special Caution

- The product is for indoor use only and is not suitable for outdoor or any location with drafts.
- Use caution with children under the age of 8. Children should keep a safe distance to avoid inhaling snow particles and possible suffocation.

1) List of parts

No.	Description	Quantity
1	Transformer	1 unit
2	Umbrella-shaped base	1 set
3	Ring support	1 pc
4	Figures (3 pcs)	1 set (3 pcs)
5	Christmas tree	2 trees
6	Light String	1 string(2 tips)
7	Street lamp (Combined type)	1 set
8	Wreath	1 pc
9	Snow flakes	1 bag
10	Top	1 pc

2) Schematic

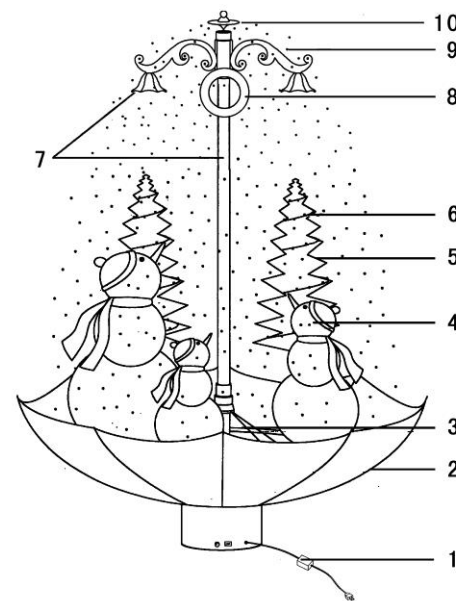

3) Installation

Install Street Lamp

- Unfold the umbrella-shaped base.
- Assemble the street lamp components as shown on schematic and insert the plug at bottom into No. 1 jack in the base.
- **Note:** Tighten up each screw so that the lamp tube forms a strong base for the product.

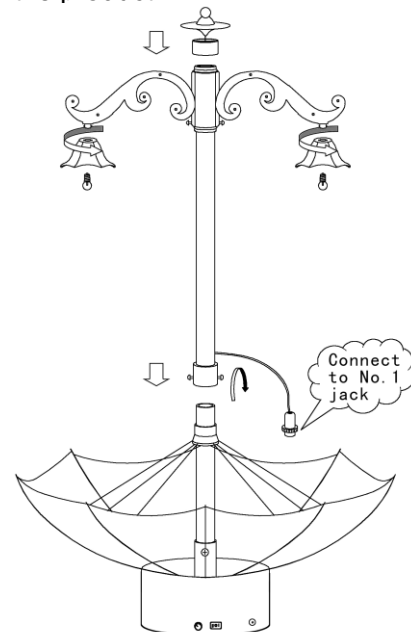

4) Fit ring support and its fittings

- Assemble the corresponding numbered ring support with its fittings as illustrated.

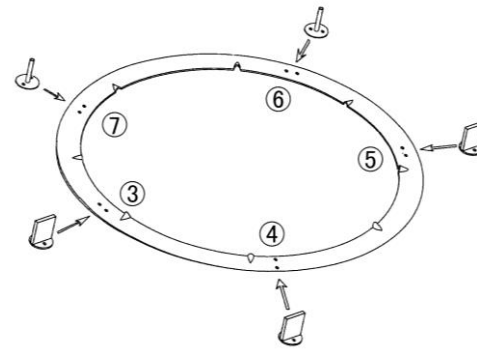

- Put the ring support on umbrella support in the direction as indicated by ↓

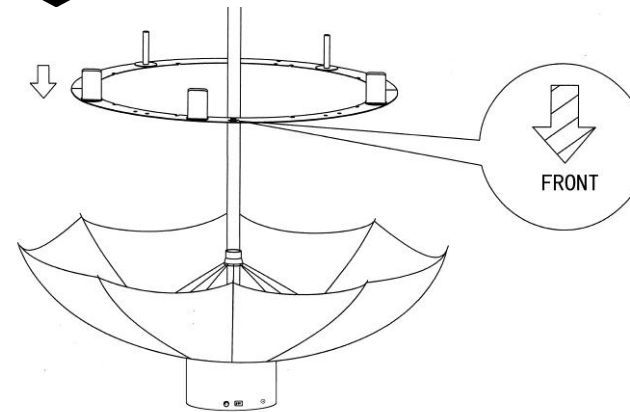

- Mount the figures and Christmas trees one by one onto the ring support as illustrated.

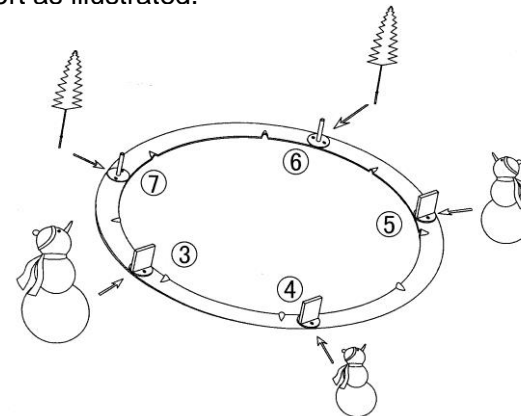

5) Arrange the trees and fit the light string

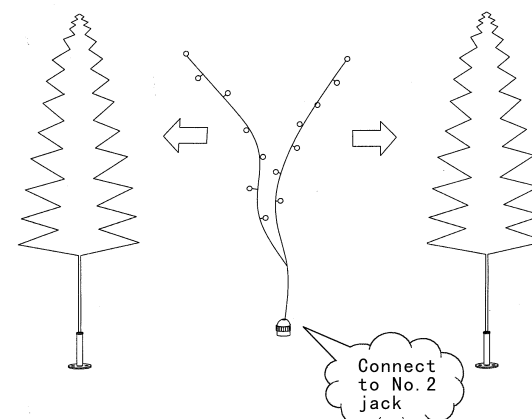

- Unfold branches of two trees to get the desired shape. Insert the plug of light string into the No. 2 jack in the base and decorate the string tips on the trees respectively.

6) Testing the Snowflakes

- Confirm all the above instructions have been completed.
- Make sure there is no blockage in the snow container so there is a flow of snowflakes.
- Set the switch at OFF and connect the transformer into the power source.
- Put a small amount of snow flakes at the bottom of the snow container, and turn on the switch. Check if flakes are spouting out from the top of the street lamp. Music and lamps should be properly functioning. If there are any issues, check the contact of wiring and try it again until all functions are resolved.

7) Pour in the flakes

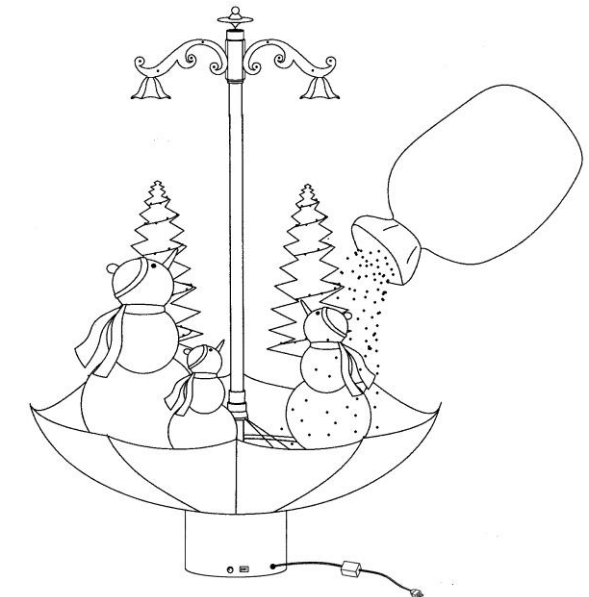

- Turn off the switch. Evenly distribute the snowflakes into the umbrella shaped base. It is suggested to keep an appropriate amount of snowflakes aside, for when some fall out.

8) Completion of assembling

- Fit the wreath.
- Turn on the switch; you will see snow flakes spouting from the top, the light string flashing and music starting. Now all assembling has been completed.

9) Adjust and enjoy

- Adjust the wind switch to get appropriate wind for best snow falling effect, and also avoid flakes flying out of the container.

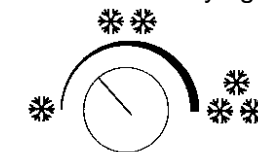

- Music can be controlled by the switch and can be turned off when not needed:

- I—Music turned off and other functions are normal
- II—Music turned on and all functions are normal.

